

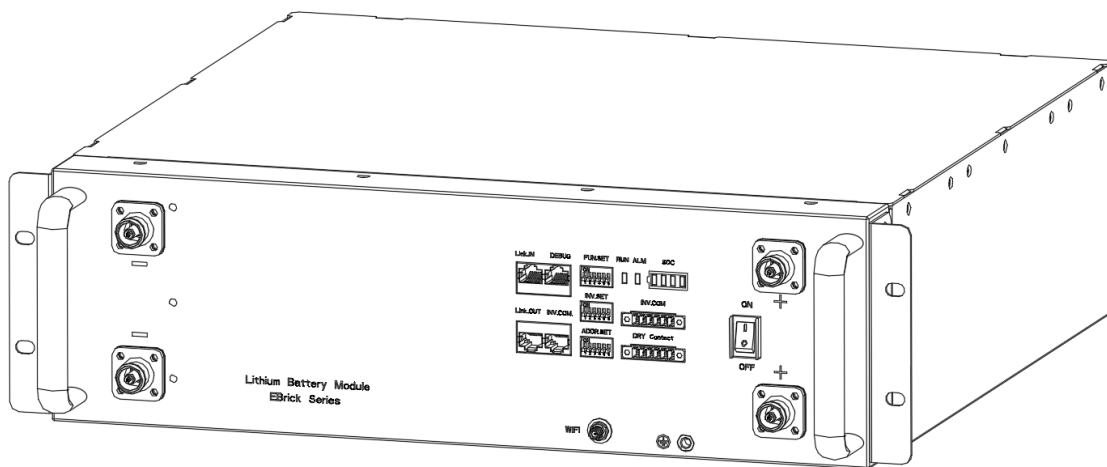

User Manual of EBrick Series



Email: support@renonpower.com

Official website: www.renonpower.com

Address: 5900 Balcones Drive STE 100, Austin, TX 78731, United States



Revision History

Ver.	Date	Revise contents	Reviser
A00	2022.11.25	New Edition	Tom
A01	2022.12.12	Change the picture of cover page.	Tom
A02	2023.02.09	Add 2 Inverter Dial Codes.	Mike
A03	2023.05.26	Update the chapter of WIFI Configuration	Mike
A04	2023.07.18	Add the Pin order select box to accessory list and it's usage to chapter 3.5.	Aaron
A05	2023.09.14	Modify the maximum number of parallel machines to 31	Vivid



Table of Contents

1 Safety Instructions	5
1.1 General Safety Precautions	5
1.2 Transportation and Storage Precautions	6
1.3 Installation Precautions	6
1.4 Usage Precautions.....	7
1.5 Response to Emergency Situations.....	8
1.6 Qualified Personnel.....	9
2 Introduction	10
2.1 Product features.....	10
2.2 Specifications	11
2.3 Interface Introduction	12
2.3.1 Inverter Communication Port (RJ45).....	12
2.3.2 Link-out Parallel Communication Port	13
2.3.3 Link-in Parallel Communication Port.....	14
2.3.4 Debug Port.....	14
2.3.5 Address Dial Switch.....	15
2.3.6 Inverter Dial Switch	17
2.3.7 Function Dial Switch	18
2.3.8 LED Indicator of WIFI Status.....	18
2.3.9 LED Indicator of Alarm Status.....	19
2.3.10 LED Indicators of SOC Status.....	19
2.3.11 Inverter Communication Port (connector)	20
2.3.12 Dry Contact & GPIO Port.....	20
2.3.13 Power Switch.....	21
2.3.14 Power Positive	21
2.3.15 Power Negative	21
2.3.16 WIFI Antenna Port.....	21
2.3.17 Grounding Connection Port	21
3 Installation and Usage	22
3.1 Safe Handling Guide.....	22
3.1.1 Familiar with the product.....	22
3.1.2 Precautions before installation	22



3.1.3 Tools	22
3.1.4 Safety gear.....	22
3.2 Installation location	23
3.3 Package items.....	23
3.4 Installation.....	24
3.4.1 Installation with optional battery rack.....	25
3.4.2 Installation with standard cabinet.....	27
3.5 Connections of Cable and Power.....	28
3.6 Wi-Fi configuration	31
4 Troubleshooting & Maintenance	37
4.1 Regular maintenance	37
4.2 Troubleshooting.....	37



1 Safety Instructions

Safety Instructions for safety reasons, installer and user are responsible for familiarizing themselves with the contents of this document and all warnings before installation and usage.

1.1 General Safety Precautions

- Please carefully read this manual before any work is carried out on the product, and keep it located near the product for future reference.
- All installation and operation must comply with local electrical standards.
- Please ensure the electrical parameters of the product are compatible to related equipment.
- Do not open or dismantle the battery module. Electrolyte is very corrosive. In normal working conditions contact with the electrolyte is impossible. If the battery casing is damaged, do not touch the exposed electrolyte or powder because it is corrosive.
- The electronics inside the product are vulnerable to electrostatic discharge, keep it away from that.
- Do not place items or tools on the product.
- Do not damage the product by dropping, deforming, impacting, cutting.
- Keep the product away from liquid. Do not touch the product if liquid spills on it. There is a risk of electric shock.
- Do not expose the product to flammable or harsh chemicals or vapors.
- Do not paint any part of the product, include any internal or external components.
- Do not change any part of the product, especially the battery and cell.
- Besides connection under this manual, any other foreign object is prohibited to insert into any part of the product.
- The warranty claims are excluded for direct or indirect damage due to items above.
- Batteries must not be mixed with domestic or industrial waste.



- Batteries marked with the recycling symbol must be processed via a recognized recycling agency. By agreement, they may be returned to the manufacturer.

1.2 Transportation and Storage Precautions

- The batteries must be transported according to UN3480, they must be packed according to packaging requirements of Special Regulation 230 of IMDG CODE (40-20 Edition) for maritime transport, and P965 IA for air transport (SOC less than 30%). The original packaging complies with these instructions.
- If the product needs to be moved or repaired, the power must be cut off and completely shut down.
- The product must be transported in its original or equivalent package; the battery module must be placed at upright position.
- The modules are heavy. Ensure adequate and secure mounting and always use suitable handling equipment for transportation.
- If the product is in its package, use soft slings to avoid damage.
- Do not stand below the product when it is hoisted.
- During transportation, severe impact, extrusion, direct sunlight, and rain should be avoided.
- Store in a cool and dry place.
- Store the product in clean environment, free of dust, dirt, and debris.
- Store the product out of reach of children and animals.
- Don't store the battery under 50% SOC for over one month, this may result in permanent damage to the battery and void the warranty.
- If the product is stored for long time, it is required to charge the battery module every 3 months, and the SOC should be no less than 90%.

1.3 Installation Precautions

- Do not install the product in an airtight enclosure or in an area without



ventilation.

- Do not install the product in living area of dwelling units or in sleeping units other than within utility closets and storage or utility spaces.
- If the Product is installed in a garage or carport, ensure there is adequate clearance from vehicles.
- While working on the product wear protective eyeglasses and clothing.
- Handle the battery wearing insulated gloves.
- Use insulated tools. Do not wear any metallic items such as watches, bracelets, etc.
- Please turn-off related circuit breakers before and during the installation to avoid electric shock.
- Do not connect any AC conductors or photovoltaic conductors directly to the battery pack. These are only to be connected to the inverter.
- Wiring must be correct, do not mistake the positive and negative cables, and ensure no short circuit with the external device.
- Over-voltages or wrong wiring could damage the battery pack and cause combustion which can be extremely dangerous.
- Make sure the product is well grounded, and comply with local specifications, the recommended grounding resistance is less than 1Ω .
- Handle with care because Li-ion Battery is sensitive to mechanical shock.

1.4 Usage Precautions

- Before starting the system, the operator should strictly check the connection terminals to ensure that the terminals are firmly connected.
- If there's a circuit breaker between battery and inverter, the breaker is supposed to be on before power on the battery.
- Do not open the product, connect, or disconnect any wires when it's working to avoid electric shock.
- Battery needs to be recharged within 12 hours after fully discharged.



- The default temperature range over which the battery can be discharged is -4 °F (-20°C) to 122°F (50°C). Frequently discharge the battery in high or low temperature may deteriorate the performance and life of the battery pack.
- The default temperature range over which the battery can be charged is 32°F (0°C) to 122°F (50°C). Frequently charge the battery in high or low temperature may deteriorate the performance and life of the battery pack.
- Do not charge or discharge a damaged battery.
- Please contact the supplier within 24 hours if there is something abnormal.

1.5 Response to Emergency Situations

- Damaged batteries are dangerous and must be handled with extreme care. They are not suitable for use and may cause danger to persons or property. If the battery pack appears to be damaged, place it in the original container and return it to an authorized dealer.
- If the battery pack is wet or submerged in water, do not allow any person access, and then contact authorized dealer for technical support.
- In case of fire, use the carbon dioxide, FM-200 or ABC dry powder fire extinguisher; if possible, move the battery pack to a safe area before it catches fire.
- If a user happens to be exposed to the internal materials of the battery cell due to damage on the outer casing, the following actions are recommended.
- In case of inhalation: Leave the contaminated area immediately and seek medical attention.
- In case of contact with eyes: Rinse eyes with running water for 15 minutes and seek medical attention.
- In case of contact with skin: Wash the contacted area with soap thoroughly and seek medical attention.
- In case of ingestion: Induce vomiting and seek medical attention.



1.6 Qualified Personnel

The installation guide part described herein is intended for use by skilled staff only. A skilled staff is defined as a trained and qualified electrician or installer who has all the following skills and experience:

- Knowledge of battery' specification and properties.
- Knowledge of the installation of electrical devices.
- Knowledge of torsion and screwdrivers for different types of screws.
- Knowledge of local installation standards.
- Electrical license for battery installation required by the country or state.
- Knowledge of the dangers and risks associated with installing and using electrical devices and acceptable mitigation methods.
- Knowledge of and adherence to this guide and all safety precautions and best practices.

For safety reasons, installers are responsible for familiarizing themselves with the contents of this document and all warnings before performing installation and usage.



2 Introduction

The EBrick series is a lithium iron phosphate battery-based energy storage product developed and produced by RENON, it can supply reliable power for nearly all kinds of household appliances and equipment.

The EBrick series consists of a built-in BMS battery management system, which can manage and monitor cells information including voltage, current and temperature, used to limit the balance current between different batteries when parallel use.

Multiple battery stacks are allowed to be connected to expand capacity and power to meet the requirements of longer power supporting duration and higher power consumption.

The EBrick series is designed to suitable with standard 19-inch cabinet, and all the power wires, communication wires, switch and indicators were designed to front panel, which allows user to install them quickly, and easy to operate.

2.1 Product features

- The whole product is non-toxic, pollution-free and environment-friendly.
- Cathode material is made from LiFePO₄ with safety performance and long cycle life.
- Small volume, light weight, plug-in embedded design module, easy to install and maintain.
- Working temperature range is from -4°F to 122°F (-20°C to 50°C) with excellent discharge performance and cycle life.
- Battery management system (BMS) has protection functions including over-discharge, over-charge, and over-current and high/low temperature.
- The battery has less self-discharge, up to 3 months without charging it on shelf, no memory effect, excellent performance of shallow charge and discharge.
- The system can automatically manage battery charge and discharge state. and save energy cost by various control strategy.



2.2 Specifications

Item	R-EB005161 / R-EB005161-H
Battery Chemistry	LiFePO4
Nominal Energy (kWh)	5.12
Nominal Capacity (Ah)	100
Max. Charging/Discharging Current (A)	95
Nominal Voltage (V)	51.2
Recommend Charging Voltage (V)	56.8
Max. Charging Voltage (V)	58.4
Discharge Cut-off Voltage (V)	43.2
Heating Film Resistance(Ω)	16 (-H model only)
Heating Start Temperature (°F/°C)	41/5 (-H model only)
Operation Temperature(°F/°C)	Discharge: -4~122 / -20~50 Charge: 32~122 / 0~50
Safety Function	Over-charge, Over-discharge, Over-current, Low/High-temperature, Short-circuit Protections
Parallel Capacity	Maximum 31
Communication	RS485/CAN/Wi-Fi
Weight (lbs/kg) (Approx.)	99/45
Physical Dimensions (inches/mm) (W*D*H)	17.3*16.5*5.2/440*420*132 without the rack mounting kit, handle, wiring terminal
	19.1*18.0*5.2/485*458*132 with the rack mounting kit, handle, wiring terminal
Level of Protection	IP20
Cycle Life	8000 cycles @77°F(25°C),0.5C,80%DOD,80%EOL
Designed Calendar Life	10 Years



2.3 Interface Introduction

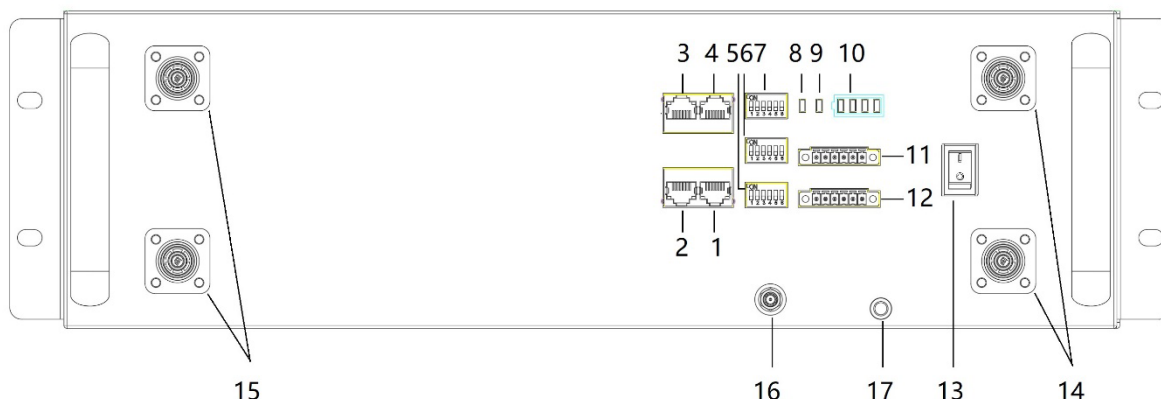

Figure 1.3.1 Battery ports from the front view

No.	Instructions	No.	Instructions
1	Inverter Communication Port (RJ45)	10	LED Indicators of SOC Status
2	Link-out Parallel Communication Port	11	Inverter Communication Port (connector)
3	Link-in Parallel Communication Port	12	Dry contact & GPIO Port
4	Debug Port	13	On/Off
5	Address Dial Switch	14	Power Positive *2
6	Inverter Dial Switch	15	Power Negative *2
7	Function Dial Switch	16	WiFi Antenna port
8	LED Indicator of WIFI Status	17	Grounding Connection Port
9	LED Indicator of Alarm Status		

2.3.1 Inverter Communication Port (RJ45)

Terminal type: RJ45

Usage: communicate with inverter, PCS or other equipment.

Installer needs to check the cable pin out before connecting inverter to the battery in order to gain the communication.



For the general information or technical matters in regarding to inverter, please refers to user manual.

Illustration for battery connection port as shown below:

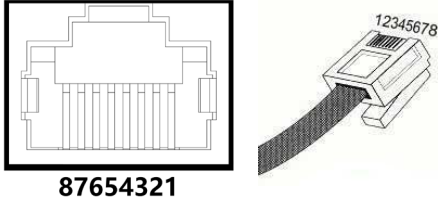
Port definitions	RJ45 Pin	Function
	1	Inverter.RS485-B
	2	Inverter.RS485-A
	3	Inverter.RS485-GND
	4	Inverter.CANGND
	5	Inverter.CANGND
	6	Inverter.RS485-GND
	7	Inverter.CANH
	8	Inverter.CANL

2.3.2 Link-out Parallel Communication Port

Terminal type: RJ45

Usage: Connect this port with Link-in port of the next battery when parallel

Defined as follows:

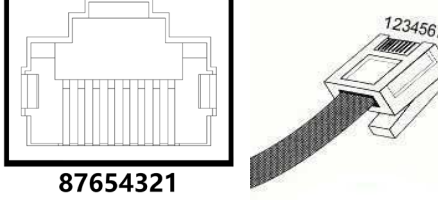
Port definitions	RJ45 Pin	Function
	1	Parallel.CANL
	2	Parallel.CANH
	3	Parallel.CANGND
	4	Switch control output -
	5	Switch control output +
	6	Parallel.CANGND
	7	Address configure output -
	8	Address configure output +



2.3.3 Link-in Parallel Communication Port

Terminal type: RJ45

Usage: Connect this port with Link-out port of the previous battery when parallel use.

Defined as follows:

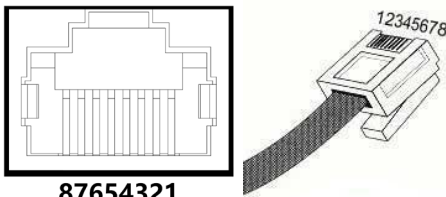
Port definitions	RJ45 Pin	Function
 <p>87654321</p>	1	Parallel.CANL
	2	Parallel.CANH
	3	Parallel.CANGND
	4	Switch control input -
	5	Switch control input +
	6	Parallel.CANGND
	7	Address configure input -
	8	Address configure input +

One switch power on and Automatic address configuration functions are disabled by default, contact us for support if you need these functions.

2.3.4 Debug Port

Terminal type: RJ45

Usage: debug port of the system which used by technician only.

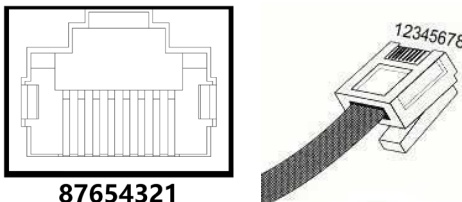
Port definitions	RJ45 Pin	Function
 <p>87654321</p>	1	Debug.CANL
	2	Debug.CANH
	3	Reserved.CANGND
	4	Debug.CANGND
	5	Debug.CANGND
	6	Reserved.CANGND
	7	Reserved.CANL
	8	Reserved.CANH



2.3.5 Address Dial Switch

- 1) Use this Dial Switch to set the address of each battery and then turn on to activate the system when it needs to be in parallel with other battery units.
- 2) When the system only has one battery set, dial the address to 1.
- 3) When the system used in parallel mode, set the address start from 1 and increased by the number of battery units in order to communicate with other battery.
- 4) Only the battery with address of 1 is able to communicate with the inverter.
- 5) The illustration of dialing as shown below:

Code	Dial Switch Position	Definition
1		Set as battery 1 (communicate with inverter by this battery)
2		Set as battery 2
3		Set as battery 3
4		Set as battery 4
5		Set as battery 5
6		Set as battery 6
7		Set as battery 7
8		Set as battery 8
9		Set as battery 9
10		Set as battery 10
11		Set as battery 11
12		Set as battery 12
13		Set as battery 13



14		Set as battery 14
15		Set as battery 15
16		Set as battery 16
17		Set as battery 17
18		Set as battery 18
19		Set as battery 19
20		Set as battery 20
21		Set as battery 21
22		Set as battery 22
23		Set as battery 23
24		Set as battery 24
25		Set as battery 25
26		Set as battery 26
27		Set as battery 27
28		Set as battery 28
29		Set as battery 29
30		Set as battery 30
31		Set as battery 31



2.3.6 Inverter Dial Switch

Code 0 ~ 16 of this Dial Switch are used to match which brand of inverter is using.

(Please refer to Inverter Matching Guide, download from our website:

<https://www.renonpower.com/datasheet.html>

Open the website and select Ebrick LV, and download the Inverter Matching Guide.)

The definitions of code 0 ~ 16 are shown as below table.

Code	Dial Switch Position	Brand	Logo
0		(Set by software)	
1		(Reserved)	
2		Schneider_Gateway	
3		Sol-Ark	
4		Solis_LV	
5		Goodwe_LV	
6		Studer_Xtender	
7		Victron_color control	
8		SMA_LV	
9		Sermatec_LV	
10		Sofar_LV	
11		DEYE	



12		Growatt_SPF	
13		Growatt_SPH&SPA	
14		Must	
15		MEGAREVO	
16		SAJ	

Code 63 is used for special function, defined as below:

Code	Dial Code Switch Position	Definition
63		The battery enters WiFi configuration mode, see chapter 3.6 for more information.

2.3.7 Function Dial Switch

Use this dial switch to matching the communication impedance, should set as below:

Optimize and enhance the communication between the batteries.

Code	Dial Code Switch Position	Definition
0		① When used as single battery; ② When used in a parallel system and not being the first or last battery.
32		③ When used as the first or last battery in a parallel system.

2.3.8 LED Indicator of WIFI Status

This green LED is used to indicate the status of WIFI connection.



The status shown as below table.

LED Blinking Mode	Status
No Light	Battery is off.
Blinking	Connecting the sever properly with this WIFI.
Rapid Blinking-	Unable to connect the sever with this WIFI.
Solid Green	Waiting for WIFI configuration.

2.3.9 LED Indictor of Alarm Status

This red LED is used to indicate the status of alarm status.

The status shown as below table.

LED Blinking Mode	Status
No Light	There is no alarm.
Blinking	Warning alarm for over current, over temperature, low voltage and over voltage.
Rapid Blinking-	Protection circuit is been triggering.
Solid Red	Error occurs.

2.3.10 LED Indictors of SOC Status

This 4 green LEDs is used to indicate the SOC status of the battery.

The status shown as below table.

LED Blinking Mode	Status of SOC
No Lights	SOC is 0%.
Solid Green of 1 LED	$0\% < SOC \leq 25\%$
Solid Green of 2 LEDs	$25\% < SOC \leq 50\%$



Solid Green of 3 LEDs	50% < SOC ≤ 75%
Solid Green of 4 LEDs	75% < SOC ≤ 100%
Blinking Green	The battery is been charging.

2.3.11 Inverter Communication Port (connector)

Terminal type: 6-Pin terminal block

Usage: reserved for direct connection with inverter, same function as the RJ45 port (chapter " **Inverter Communication Port (RJ45)**"), either one of these two will be used.

Defined as below:

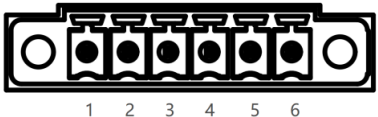
6pin Terminal	Pin	Usage
	1	Inverter.RS485-B
	2	Inverter.RS485-A
	3	Inverter.RS485-GND
	4	Inverter.CANL
	5	Inverter.CANH
	6	Inverter.CANGND

2.3.12 Dry Contact & GPIO Port

Terminal type: 6-Pin terminal block

This is for General-purpose input & output (GPIO) which reserved for future communication and used for an uncommitted digital signal pin on an integrated circuit or electronic circuit (e.g. MCUs/MPUs) board which may be used as an input or output, or both, and is controllable by software.

Defined as bellow:

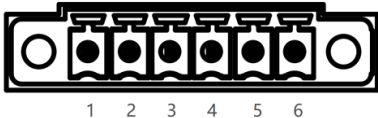
6pin Terminal	Pin	Usage
	1	GPO_1+
	2	GPO_1-
	3	(No Connection)
	4	GPO_2+



	5	GPO_2-
	6	(No Connection)

2.3.13 Power Switch

This physical switch allows you turn the battery on or off.

- 1) The battery is on when the switch in the up position.
- 2) The battery is off when the switch in the down position.

2.3.14 Power Positive

Terminal type: Terminal for 25 mm² power cable

Usage: connect to inverter's positive terminal.

2.3.15 Power Negative

Terminal type: Terminal for 25 mm² power cable

Usage: connect to inverter's negative terminal.

2.3.16 WIFI Antenna Port

Connect the WIFI antenna to the port in order to get the APP and WEB connection.

2.3.17 Grounding Connection Port

This port is used to ground wire connection for safety reason, please refer to chapter of Installation.



3 Installation and Usage

3.1 Safe Handling Guide

3.1.1 Familiar with the product

Be careful when unpacking the system. Every module of the product is heavy. Don't lift them with a pole. The weight of the modules can be found in the chapter "**Specifications**".

3.1.2 Precautions before installation

Before installation, be sure to read the contents in chapter "**Safety Precautions**", which is related to the operation safety of installation personnel, please pay attention to it.

3.1.3 Tools

The following tools are required to install the product:

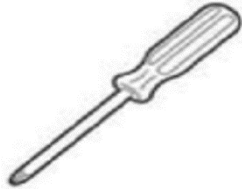

Screwdriver

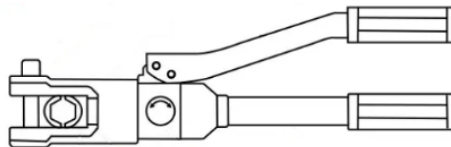

Hydraulic pliers

Use properly insulated tools to prevent accidental electric shock or short circuits. If insulated tools are not available, cover the entire exposed metal surfaces of the available tools, except their tips, with electrical tape.

3.1.4 Safety gear

It is recommended to wear the following safety gear when dealing with the product:



Insulated gloves

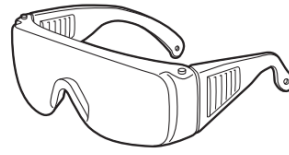

Safety goggles



Safety shoes

3.2 Installation location

Make sure that the installation location meets the following conditions:









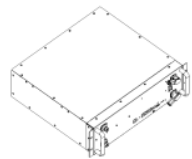

- The floor is flat and level.
- The area is completely water proof.
- The area shall avoid direct sunlight.
- There are no flammable or explosive materials.
- The distance from heat source is more than 80inch(2m).
- The ambient temperature is within the range from 32°F(0°C) to 95°F(35°C).
- The humidity is maintained at a constant level.
- There is minimal dust and dirt in the area.
- Avoid installation in an area confined or with high salinity.
- Do not install outside directly.
- Do not place in an area accessible to children or pets.

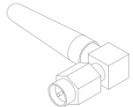
3.3 Package items

After receiving the product, please unpack the boxes, and check product and packing list first, if product is damaged or lack of parts, please contact with the local retailer.

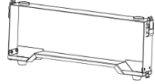
Packing List is shown in the following table:



No.	Item	Specification	Qty	Usage	Diagram
1	EBrick	R-EB005161(-H)	1		
2	Communication cable	RJ45 T568B, 8inches (160mm)	1	Communication line for parallel	
3	WiFi antenna	2.4GHz L-type	1	Connect with internet	
4	Positive connector	Orange plug for 25mm ² wire	1	Compatible with positive terminal, reserved for DIY power cable	
5	Negative connector	Black plug for 25mm ² wire	1	Compatible with negative terminal, reserved for DIY power cable	
6	Power cable-positive (customizable)	Quick plug to SC25-8, 60inches (1.5m), red	1	Connect positive of battery to inverter	
7	Power cable-negative (customizable)	Quick plug to SC25-8, 60inches (1.5m), black	1	Connect negative of battery to inverter	
8	Battery rack (optional)	18.3*7.3*2.1inches /465*186*53mm	2	Fix the battery	
9	User manual	Ebrick series	1	User manual	
10	Pin order select box (optional)	3.3*1.0*0.9inches /85*26*22mm	1	Set the pin order of the communication cable of battery and inverter, cooperate with 2 standard network cable	
11	Communication cable(optional)	Standard RJ45 network cable, 1m	2	Connect the communication pole of battery and inverter	

3.4 Installation

EBrick is designed as 3U case for standard 19-inch cabinet, it is very easy when mounting in a standard cabinet, also there are optional special racks to install batteries without cabinet. Users can select an installation mode based on



actual requirements.

3.4.1 Installation with optional battery rack

- 1) Remove the stators on both left and right sides of the battery.

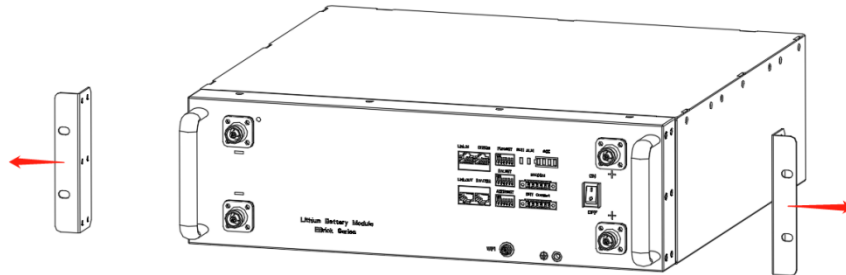

Figure 3.4.1. Remove the stators

- 2) Fasten the 2 racks to both front and rear sides of the battery.

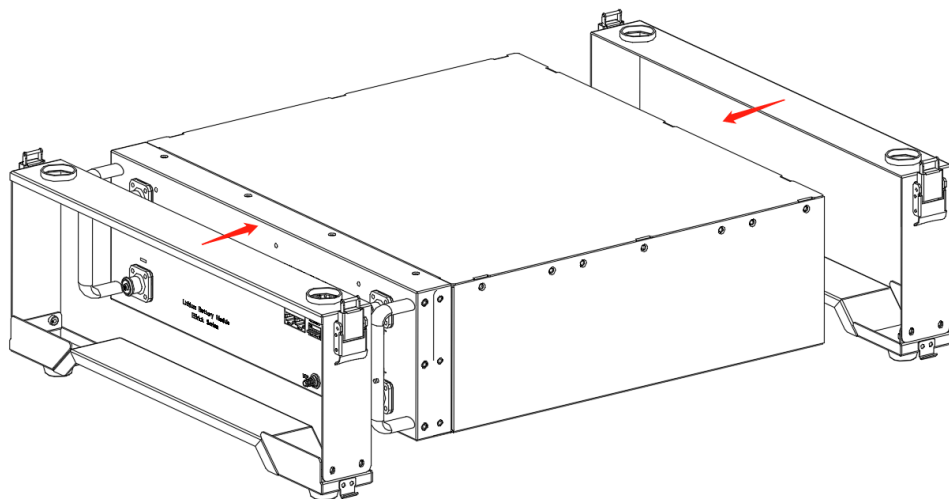

Figure 3.4.2o Fasten the racks

- 3) When used more than one battery in parallel, stack them one by one. The racks support up to 4 batteries stacked together, and do not put anything else on the top the battery.

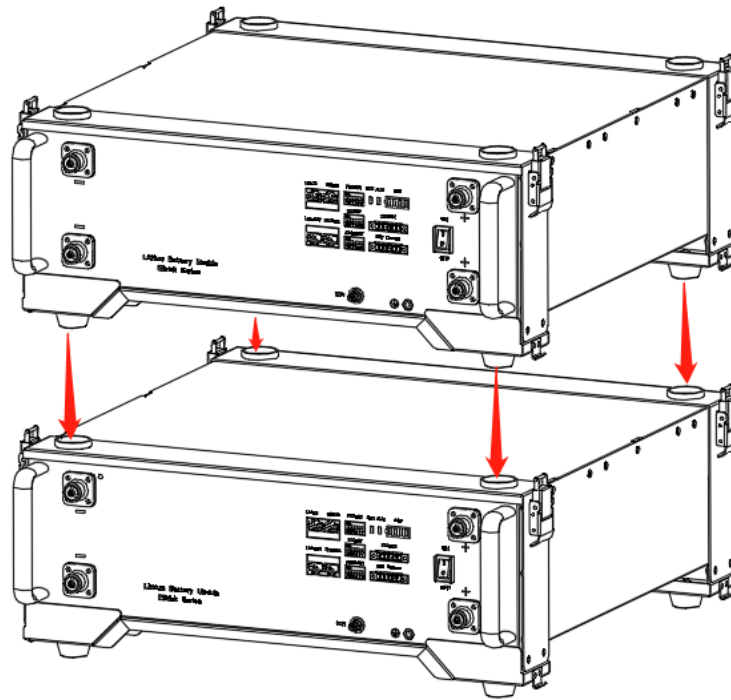

Figure 3.4.3 Stack batteries

- 4) Lock the 4 fixed attachment of each battery to make the stack stable.

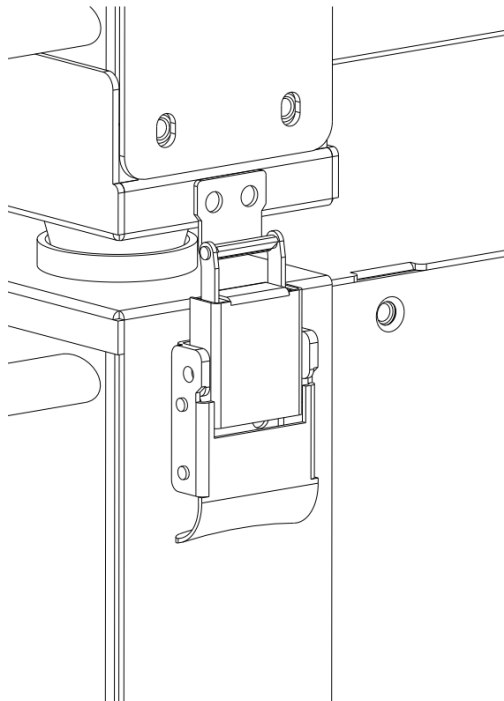

Figure 3.4.4 Lock the fixed attachment



5) Connect the ground wire as shown below. Make sure all the batteries get grounding connected properly.

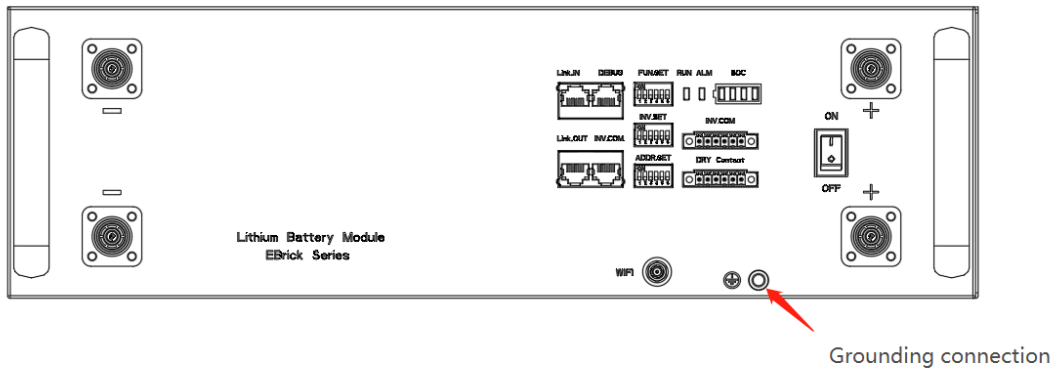

Figure 3.4.5 Grounding connection

3.4.2 Installation with standard cabinet

1) Choose a suitable 3U station for the battery, slide the battery into the cabinet shelf.

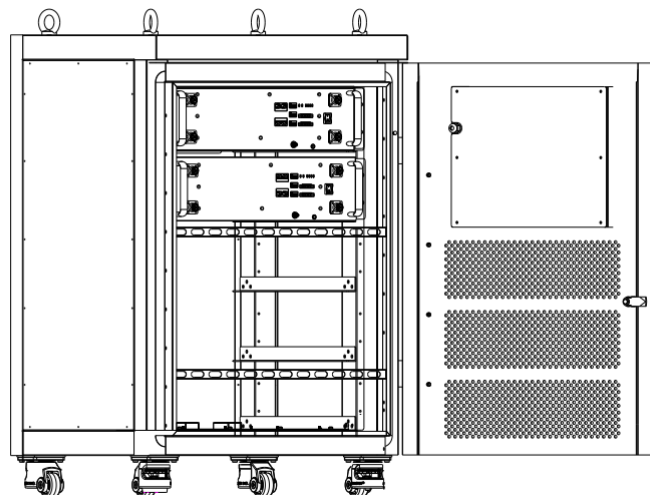

Figure 3.4.6 Slide the battery into the cabinet shelf

2) Lock the 4 screws of the battery stators.

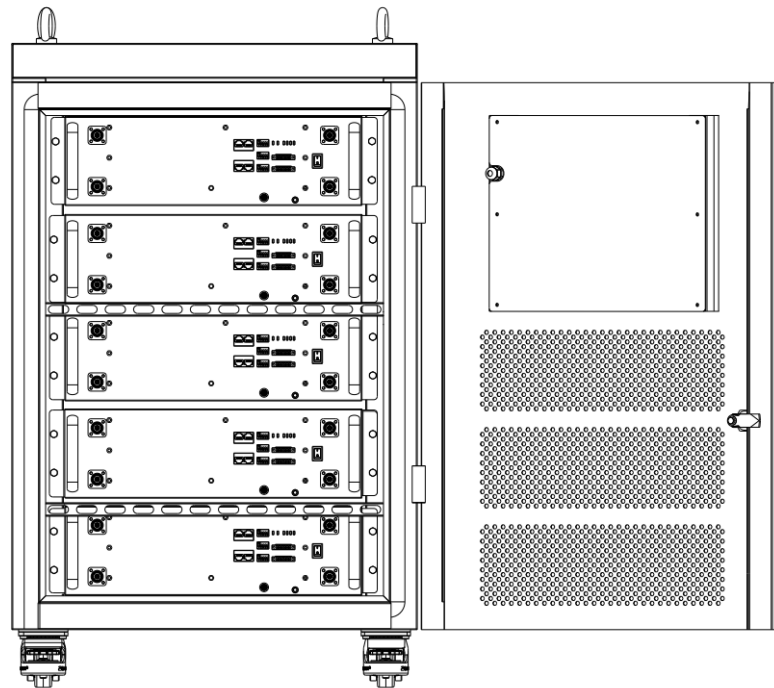
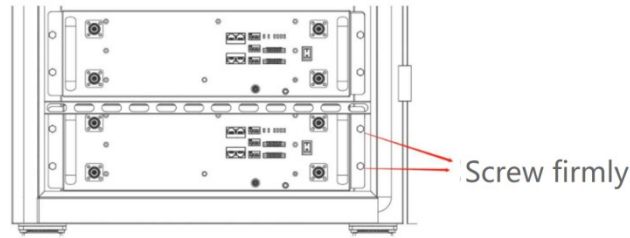

Figure 3.4.7 Lock the stators

3) Connect the ground wire as shown below. Make sure all the batteries get grounding connected properly.

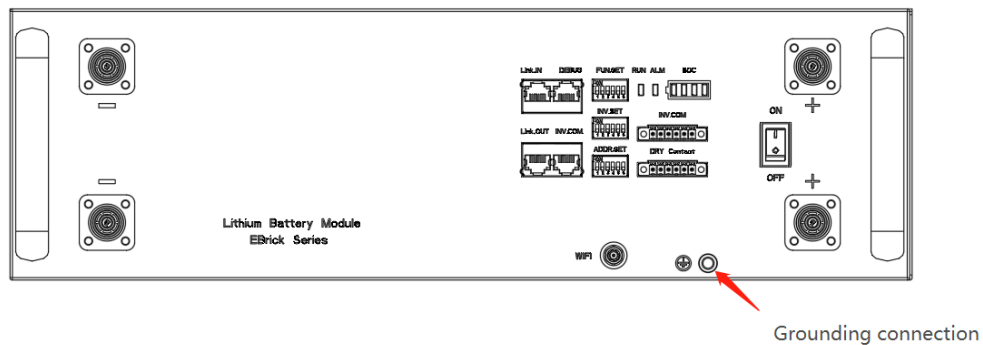

Figure 3.4.8 Grounding connection

3.5 Connections of Cable and Power



EBrick has two pairs of power terminals, that makes EBrick quite easy when



parallel use to expand the capacity of batteries, but when used to expand the system power, busbar is necessary.

- 1) Set the address dial code (**Address**) of each battery as 1, 2, 3, ... in order. Regarding the battery with address code 1, set the inverter dial code (**Inverter. Set**) to the corresponding inverter' s code.
- 2) Set the first battery and the last battery of the system' s Function dial code (**Function**)as code 32 and set Function dial code of the rest of batteries as code 0. The Function dial code (**Function**) is supposed to be set as code 0 in single battery usage.
- 3) Connect first battery positive and negative to the corresponding inverter corresponding positive and negative, the battery has two pairs of power terminal, just use any one of them.
- 4) Connect CAN/RS485 wire to the inverter port of the master controller and inverter's CAN/RS485 port.

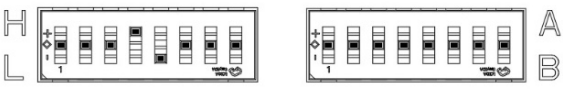
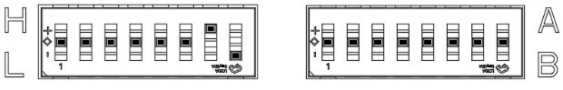
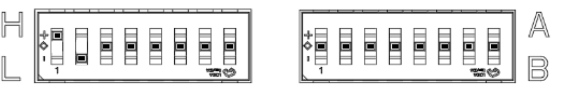
If you are using the pin order select box, please refer to the table below to set the dial switch, according to the inverter brand. If the inverter brand is not shown in the table, please refer to the inverter manual or consult Renon's engineer.

Dail switch position	Inverter brand	Comm Mode
 <p>CAN RS485</p>	Sol-Ark, Solis, GoodWe, SMA, Sermatec, Deye, MEGAREVO, SAJ, Growatt_SPH	CAN
 <p>CAN RS485</p>	Victron	CAN
 <p>CAN RS485</p>	Studer, Sofar	CAN
 <p>CAN RS485</p>	Schneider	CAN



<p>CAN RS485</p>	<p>A B</p>	Must	CAN
<p>CAN RS485</p>	<p>A B</p>	Growatt-SPF	RS485

- 5) Use parallel communication lines to connect Link-out battery 1 to Link-in of battery 2, and Link-out of battery 2 to Link-in of battery 3, and so on.
- 6) Power line connection.
 - A. In a system with no more than 5kW power, connect the power line of battery 1 to inverter, connect the power line of battery 2 to battery 1, connect the power line of battery 3 to battery 2, and so on, like shown below:

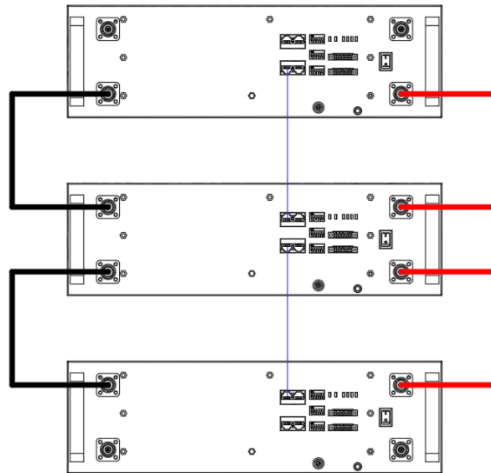

Figure 3.5.1 Connection for expand the capacity only

- B. In a system with more than 5kW power, connect power line of each battery directly to the busbar, and all the power line of inverters, the busbar must be able to withstand the maximum current of the system, like shown below:

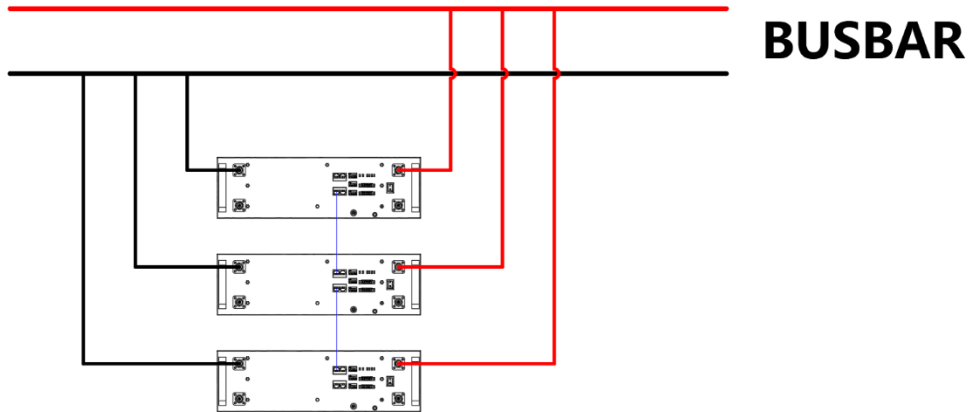
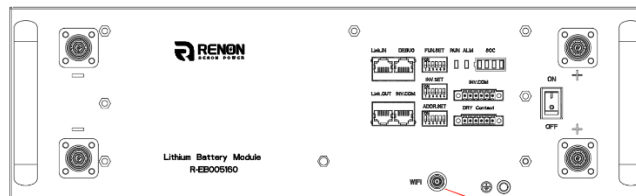

Figure 3.5.2 Connection for expand the system power

- 7) Turn on all batteries. The LEDs will indicate the battery status, make sure there is no error or low SOC.

3.6 Wi-Fi configuration

Screw the antenna into the antenna connection port firmly before Wi-Fi configuration



Wi-Fi antenna

Figure 3.6.1 WIFI antenna position

Set the inverter dial code (**INV SET**) to 63(111111) as shown below before Wi-Fi configuration.

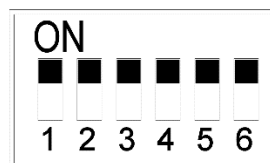

- 1) Download and install RENON APP from Google or Apple Store by searching Renon Smart.

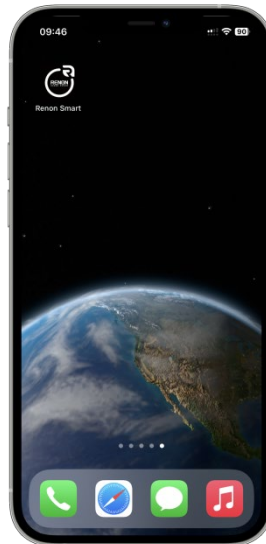

Figure 3.6.2. Install RENON APP

- 2) You may acquire the Register Code from your installer for new account registration. If you already had an account, you may use it to login the APP directly otherwise you need to create an account.

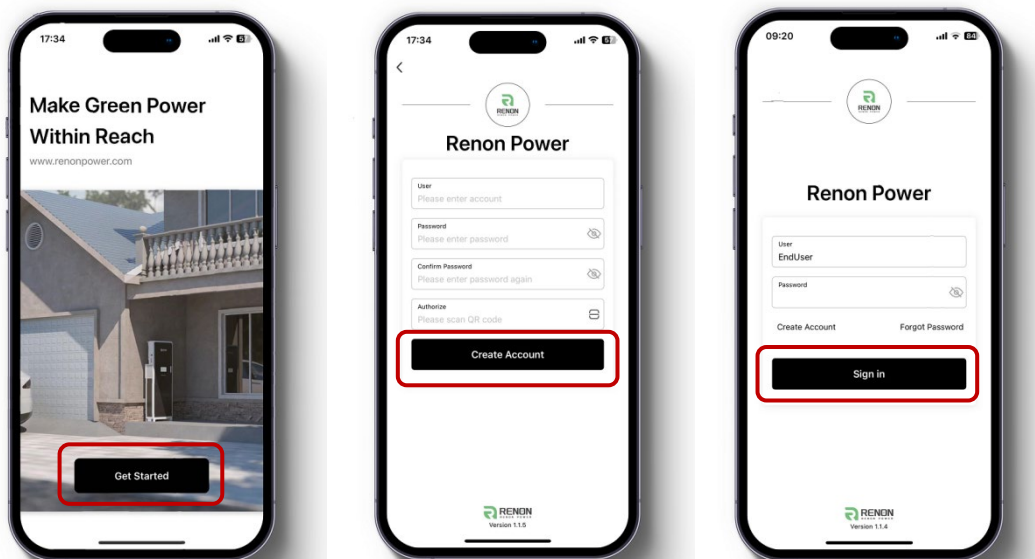

Figure 3.6.3. Start the APP & Create an account & Sign in

- 3) Turn to the page account then click the Network, following by the instruction of network setting for WIFI configuration.

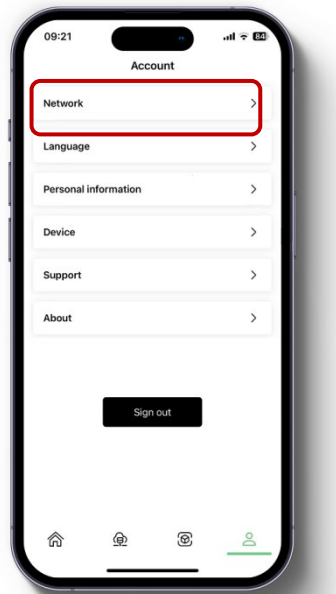

Figure 3.6.4. Network Setting

- 4) Connect your mobile phone to the WI-FI hotspot from the master controller which SSID is same as controller's serial number (SN) and the password is 12345678. Make sure this connection is successful by checking whether Wi-Fi symbol on screen shine periodically or not.

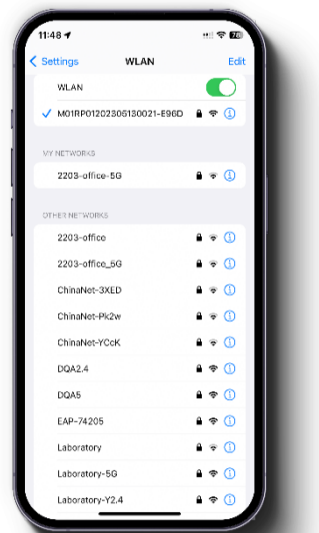

Figure 3.6.5. Connecting WIFI Hotspot of Product

- 5) Enter the SSID and password of your private WI-FI for connecting master controller to your private WI-FI. Make sure the Wi-Fi symbol on screen will shine constantly.

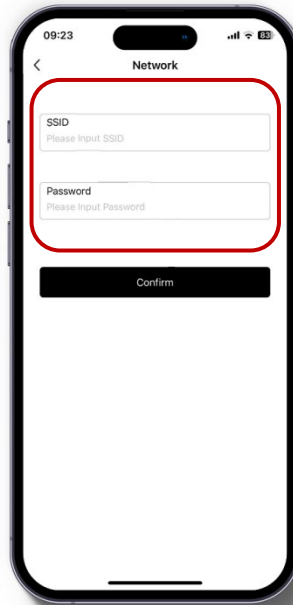

Figure 3.6.6. Connecting Private WIFI

- 6) Ask your installer to assign all your products to your account.
- 7) Turn to main page of the APP, create a plant, and set a recognizable name, your email and address for it.

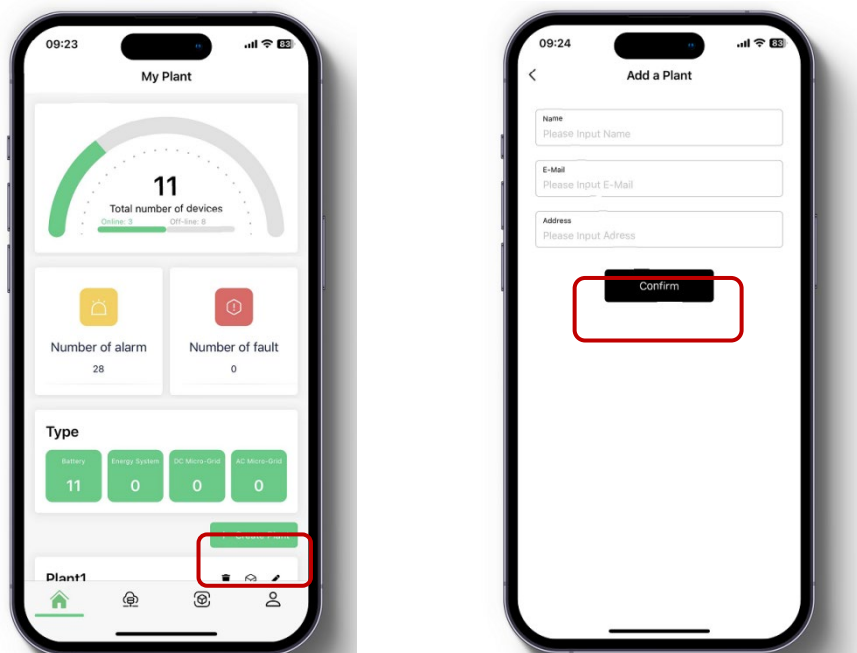

Figure 3.6.7. Create A New Plant

- 8) Click the confirm button to create your plant and all your products will show up as their SN, select proper products and confirm.

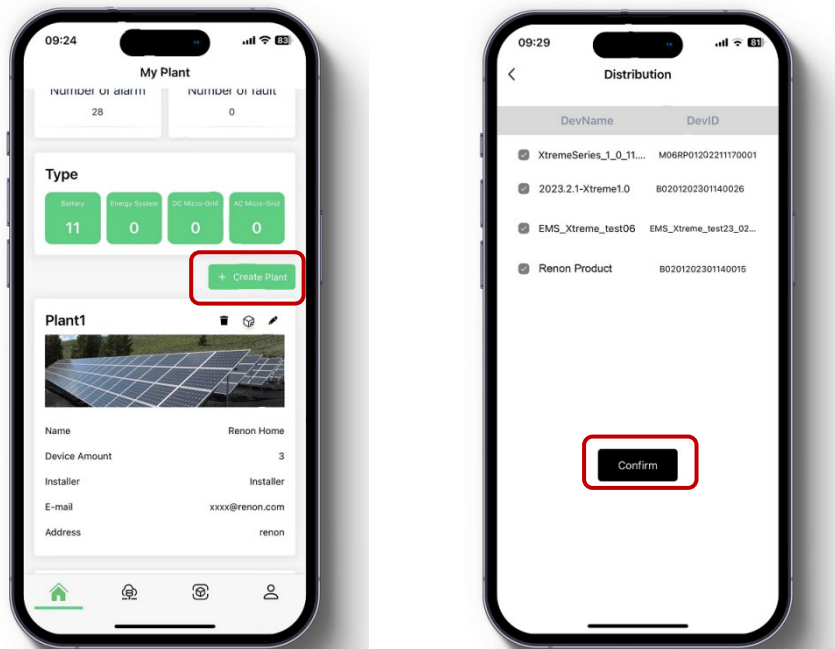

Figure 3.6.8. Manage Your Plant & Confirm Your Products

- 9) Now you can manage your products in the APP, and you can also manage them in Website, ask your installer for the site URL.

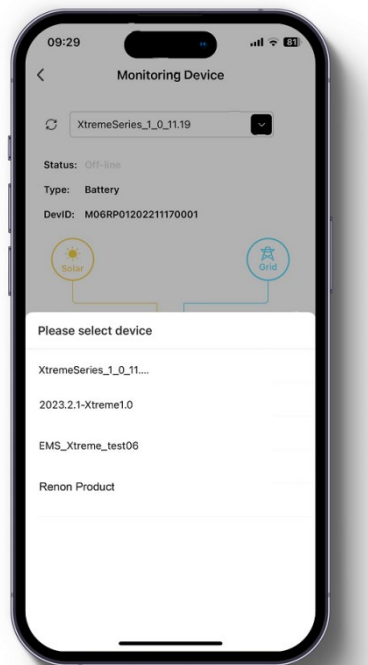

Figure 3.6.9. Manage Your Products

- 10) After the product is connected to Wi-Fi, the running status, real-time power, daily power consumption and cumulative power of the product can



be monitored in real time on the network platform or mobile APP. It can also be used to configure parameters

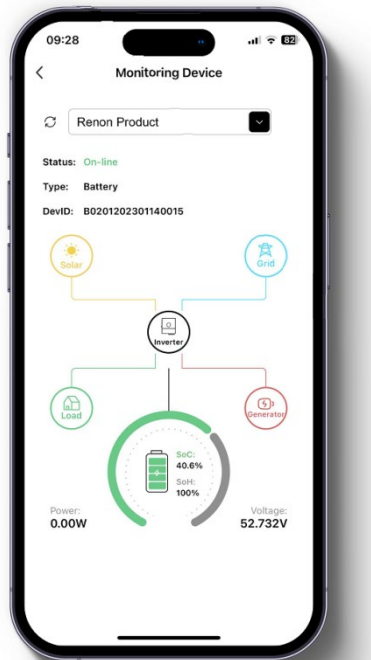

Figure 3.6.10. Monitoring Device

- 11) Set the inverter dial code to match the inverter brand after Wi-Fi configuration finished (Please refer to the chapter **2.3.3 Inverter Dial Switch**).



4 Troubleshooting & Maintenance

4.1 Regular maintenance

- 1) Check the battery modules every 3 months to verify whether there are damages.
- 2) Check the battery modules every 3 months to verify whether the operating parameter is normal or there is no abnormal heating.
- 3) Fully charge and discharge the battery system every 3 months.
- 4) Clean the battery modules with a dry rag once a month.

4.2 Troubleshooting

Phenomenon	Investigation & troubleshooting
Unable to turn on the battery	<ol style="list-style-type: none"> 1. Try to charge the battery by the activation charging function of the inverter when power is on.
No output after power on.	<ol style="list-style-type: none"> 1. Make sure the address dial code setting is correct, refer to the chapter of address dial code. 2. No lights on SOC LED Indicators and steady red on alarm LED, which indicates SOC is 0% and charged the battery please. 3. Green lights on SOC LED Indicators and steady red on alarm LED, which indicates something wrong with and check the ambient temperature of the battery please.
Unable to communicate with inverter	<ol style="list-style-type: none"> 1. Make sure the connection of communication cable and power cable is correct, refer to the chapter of connection of cable and power. 2. Make sure the address dial code of the master controller connected to inverter is 1. 3. Make sure the inverter dial code of the master controller connected to inverter is correct, refer to the chapter of inverter dial code. 4. If you are using a pin order select box, please verify that the dialing switch is configured correctly.



<p>Unable to be charged by inverter</p>	<ol style="list-style-type: none"> 1. Check whether inverter has faults. 2. Make sure the battery is allowed to be charged by inverter. 3. Make sure Time of Use of inverter setting is correct. 4. Make sure charging voltage and charging current setting of the inverter match the parameters of the battery. 5. Make sure there is no alarm (No light on alarm LED indicator). 6. Make sure power cable connection is correct.
<p>Unable to discharge while SOC is not zero.</p>	<ol style="list-style-type: none"> 1. Check whether inverter has faults. 2. Make sure the connection of cables and circuit breaker is correct. 3. Make sure the inverter setting is back up model. 4. Check whether SOC shut down value setting is over high. 5. Make sure there is no alarm (No light on alarm LED indicator).
<p>Unable to find the battery on the APP & the cloud</p>	<ol style="list-style-type: none"> 1. Make sure the antenna is screwed properly. 2. Make sure the WIFI configuration is correct. 3. Make sure the SSID & PASSWORD of your private WIFI is correct, please enter information case-sensitively without space. 4. Make sure the frequency of the WIFI connected to the product is (2.4GHz or 2.4GHz / 5GHz dual frequency integration). 5. Make sure the WIFI signal is strong enough. 6. Make sure WIFI is working. 7. Make sure installer is distributed your products on user's account. 8. Try to restart the WIFI router.